

Ground Mount Fixed-Length Frames - Installing The Banner

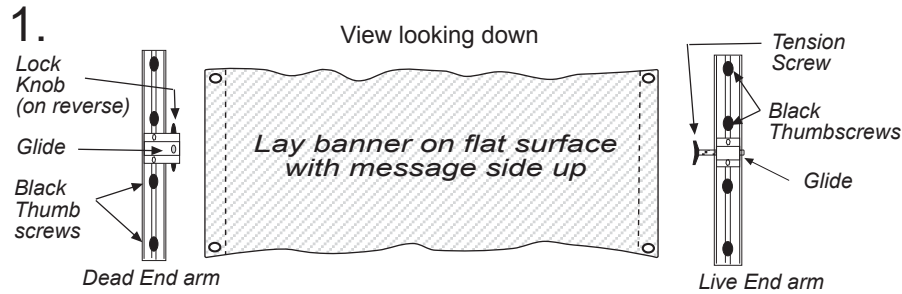

Lay out your banner and the Live End and Dead End arms as shown. The printed side of the banner should be facing up. The black Thumb screws of the arms should be facing up.

2.



Make sure the black thumb screws are retracted far enough to allow room for the hemmed ends of the banner to be inserted into the wide opening of the arm. Slide the hemmed ends of the banner all the way back into the openings of both arms and tighten all "eight" of the black thumb screws firmly.

3.



Next - turn arms away from center until they are upside down from their original position. The banner should now cover the arms and still be face up.

4.



The banner is ready to be attached to the frame.

OVERVIEW OF BANNER INSTALLATION ON GROUND MOUNT FIXED LENGTH BANNER FRAMES (see next page for step by step details)

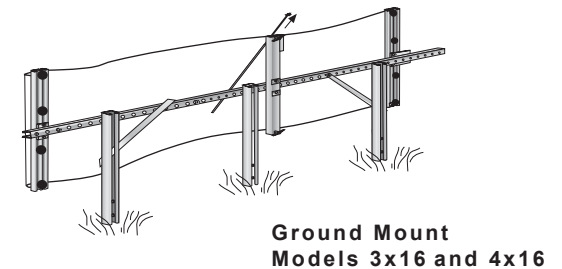
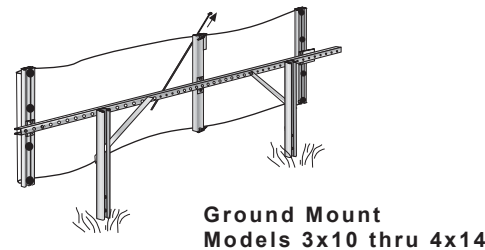
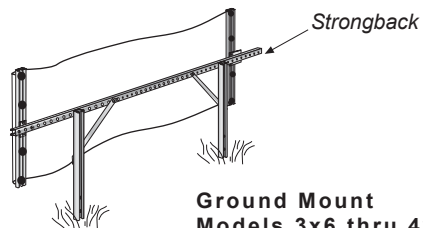

The banner installs on all Ground Mount Models by turning the End arms - with the banner attached - inward and sliding them onto the Strongback. If your model has one or more Center Arms, you will need to locate the Retaining Rod(s) on the outside of the banner. When properly installed, the banner wraps around and conceals the End arms - if the banner does not conceal the End Arms it is not installed properly and wind damage can result to your banner and framework.

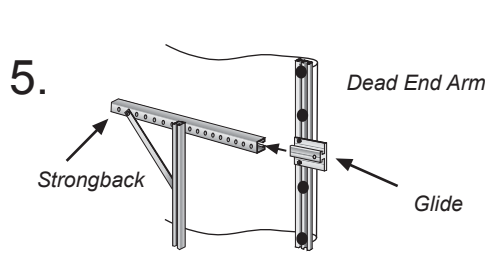

Pick up the banner and maneuver it to the front (street) side of the frame, with graphic facing the street. On the right side of the frame, turn the Dead End Arm inward and insert its Glide into the Strongback as shown. Slide the arm about 1-2 ft in along the Strongback.

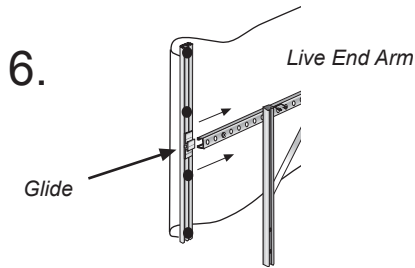

Pull the Live End Arm across the frame to the left side. Turn the Live End Arm inward so its glide can insert into the Strongback. Insert it and slide it in until it hits the white plastic Stop.

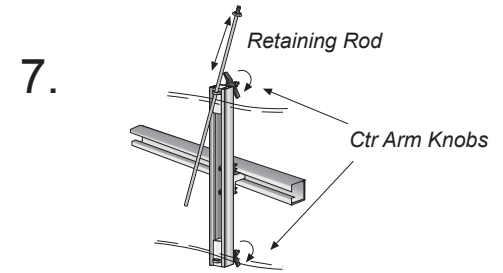

If your model has one or more Center arms, loosen the black knobs at the top and bottom and slide the Retaining Rod high enough to place it over the front of the banner. Re-insert the Rod through the bottom eyelet, but do not re-tighten the knobs yet.

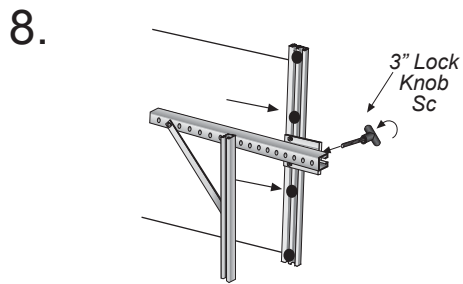

If not already done, screw the 3" Lock Knob into the Glide on the Dead End Arm. Pull the Arm outward until the banner is as tight as you can get it. Tighten the Lock Knob to hold the Arm in place.

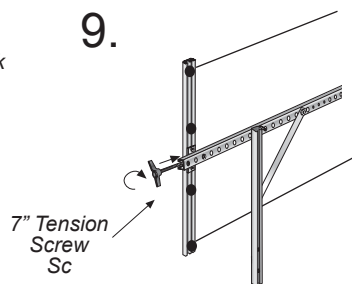

If not already done, insert the 7" Tension Screw into the threaded hole in the Glide in the Live End Arm until it hits the white plastic Stop. Continue to wind until the banner becomes fully taut. The banner should be straight across the top.

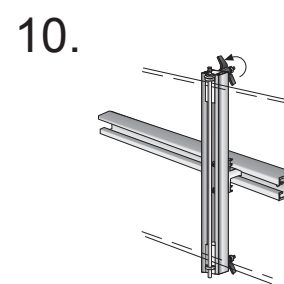

After the banner is fully taut, tighten the knobs at the top & bottom of the Center Arm(s), pulling the Retaining Rod(s) tight against the front of the banner.

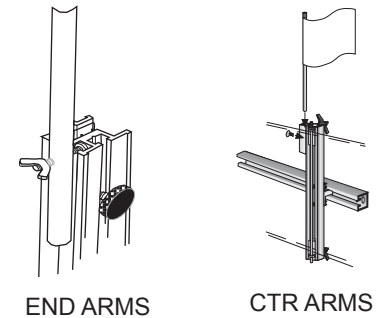

Add the Accent Flags to the Arms as shown. For End Arms, insert bolt into channel on side of arm and tighten wing nut. For Center Arms, drop into channel and tighten thumbscrew.

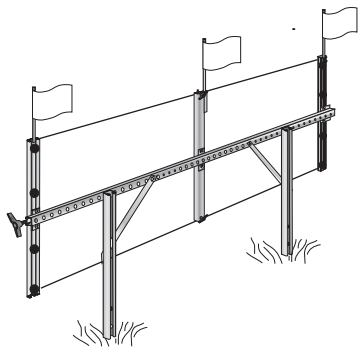

Your finished display should appear like this. The banner should be taut and straight across the top.

TO REMOVE BANNER:

1. Loosen Tension Screw on Live Arm
2. Loosen and remove Retaining Rods on Center arms
3. Loosen Lock Knob on Dead Arm and slide arm inward
4. Remove Live Arm from Strongback
5. Remove Dead Arm from Strongback
6. Loosen Thumb screws on Arms and remove banner.

Questions? Problems?

Call Voxpop at
1-800-386-9767

or e-mail:
service@voxpathms.com

www.voxpopms.com